

FASTENERS

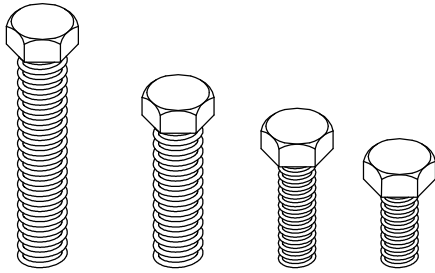

MACHINE SCREWS

High quality bronze or stainless steel machine screws for use in fastening system components – all screws have N.C. threads – note stainless steel screws may be used with copper or aluminum materials.

Copper

Cat. No. 80-12
Cat. No. 80-34
Cat. No. 80-10
Cat. No. 80-15
Cat. No. 80-20

Size

– 1/4" diam. x 1/2" long
– 1/4" diam. x 3/4" long
– 1/4" diam. x 1" long
– 1/4" diam. x 1-1/2" long
– 1/4" diam. x 2" long

Aluminum (Stainless Steel)

– Cat. No. A80-12
– Cat. No. A80-34
– Cat. No. A80-10
– Cat. No. A80-15
– Cat. No. A80-20

Cat. No. 80H-34
Cat. No. 80H-10
Cat. No. 80H-15

– 5/16" diam. x 3/4" long
– 5/16" diam. x 1" long
– 5/16" diam. x 1-1/2" long

– Cat. No. A80H-34
– Cat. No. A80H-10
– Cat. No. A80H-15

Cat. No. 80C-34
Cat. No. 80C-10
Cat. No. 80C-15

– 3/8" diam. x 3/4" long
– 3/8" diam. x 1" long
– 3/8" diam. x 1-1/2" long

– Cat. No. A80C-34
– Cat. No. A80C-10
– Cat. No. A80C-15

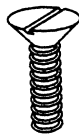

MACHINE BOLT

Flat head machine bolt of stainless steel – may be used with copper or aluminum materials.

Cat. No. A80F-10 – Stainless Steel – 1/4" diam. x 1" long

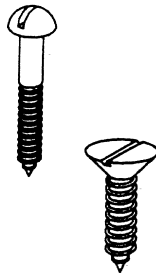

WOOD SCREWS

Slotted wood screws – note that stainless steel screws may be used with copper or aluminum materials.

Cat. No. 84C – Brass – #10 size x 1-1/2" long (Round Head)
Cat. No. A84C – Stainless – #10 size x 1-1/2" long (Round Head)
Cat. No. A84F – Stainless – #14 size x 1-1/4" long (Flat Head)

METAL SCREWS

Slotted sheet metal screw of bright finished stainless steel – may be used with copper or aluminum materials.

Cat. No. 84B-1 – #10 size x 1" long (Pan Head)
Cat. No. 84B-3 – #10 size x 3/4" long (Pan Head)
Cat. No. 84BF – #14 size x 1-1/4" long (Flat Head)

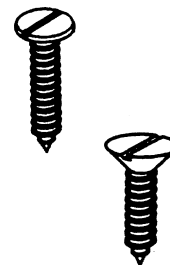

ROBBINS LIGHTNING, INC.

124 EAST SECOND STREET PHONE (660) 582-3156 FAX (660) 582-3039 P.O. BOX 440 MARYVILLE, MISSOURI 64468-0440

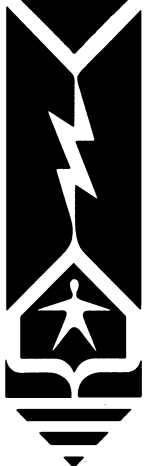

FASTENERS

MACHINE SCREW NUTS

High quality bronze or stainless steel hexagon nuts for use on machine screws, points or all thread rod – all nuts have N.C. threads – note stainless steel may be used with copper or aluminum materials.

Copper	Size	Aluminum (Stainless Steel)
Cat. No. 80E-4	– 1/4" thread size	– Cat. No. A80E-4
Cat. No. 80E-5	– 5/16" thread size	– Cat. No. A80E-5
Cat. No. 80E-6	– 3/8" thread size	– Cat. No. A80E-6
Cat. No. 80E-8	– 1/2" thread size	– Cat. No. A80E-8
Cat. No. 80E-10	– 5/8" thread size	– Cat. No. A80E-10
Cat. No. 80E-12	– 3/4" thread size	– Cat. No. A80E-12

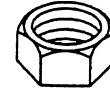

METAL FLAT WASHERS AND LOCK WASHERS

High quality bronze or stainless steel washers for use on machine screws, points or threaded rod – **NOTE:** stainless steel may be used with copper or aluminum materials.

Copper	Size	Aluminum (Stainless Steel)
Cat. No. 140	– 1/4" flat washer	– Cat. No. A140
Cat. No. 140L	– 1/4" lock washer	– Cat. No. A140L
Cat. No. 141	– 5/16" flat washer	– Cat. No. A141
Cat. No. 141L	– 5/16" lock washer	– Cat. No. A141L
Cat. No. 142	– 3/8" flat washer	– Cat. No. A142
Cat. No. 142L	– 3/8" lock washer	– Cat. No. A142L
Cat. No. 143	– 1/2" flat washer	– Cat. No. A143
Cat. No. 143L	– 1/2" lock washer	– Cat. No. A143L
Cat. No. 144	– 5/8" flat washer	– Cat. No. A144
Cat. No. 144L	– 5/8" lock washer	– Cat. No. A144L
Cat. No. 145	– 3/4" flat washer	– Cat. No. A145
Cat. No. 145L	– 3/4" lock washer	– Cat. No. A145L



Flat



Lock

NEOPRENE WASHERS

Neoprene flat washers for sealing against moisture penetration under bolts, screws or all thread rod. Washers up to 3/8" size are 1/16" thick, larger washers are 1/8" thick.

- Cat. No. 205N – 3/16" bolt
- Cat. No. 206N – 1/4" bolt
- Cat. No. 207N – 3/8" bolt
- Cat. No. 208N – 1/2" bolt



ROBBINS LIGHTNING, INC.

124 EAST SECOND STREET PHONE (660) 582-3156 FAX (660) 582-3039 P.O. BOX 440 MARYVILLE, MISSOURI 64468-0440

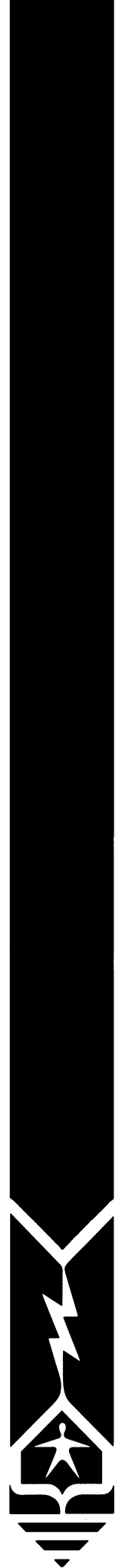

FASTENERS

STANDARD NAILS

Roofing and siding nails of copper or galvanized steel for corrosion resistant fastening – barbed construction for long lasting grip. Large head nails for base anchoring, small head nails for cable anchoring.

Copper

Cat. No. 84 – Large Head Copper – 2" long – Approx. 110 per lb.

Cat. No. 84A – Small Head Copper – 1-1/2" long – Approx. 210 per lb.

Galvanized

Cat. No. A84G – Large Head Galvanized – 1-3/4" long – Approx. 178 per lb.

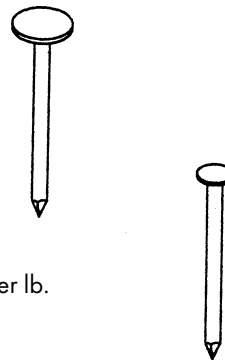

NAIL-IN ANCHOR

One-piece nail drive expansion anchor made of special zinc alloy with stainless steel nail.

Cat. No. 86Z – Copper



EXPANSION ANCHOR

Standard machine screw anchor with threaded rust-proof zinc alloy cone and special hardened lead sleeve.



Cat. No. 86 – 1/4" lead expansion anchor

Cat. No. 86A – 3/8" lead expansion anchor

Cat. No. 86C – 5/16" lead expansion anchor

TOGGLE BOLTS

Spring wing type toggle bolt, steel plated to prevent corrosion – round head slotted – for use on hollow block or tile surfaces.

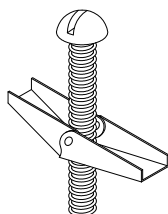

Cat. No. 78 – 1/4" diam. x 3" long

Cat. No. 78A – 1/4" diam. x 4" long



ROBBINS LIGHTNING, INC.

124 EAST SECOND STREET PHONE (660) 582-3156 FAX (660) 582-3039 P.O. BOX 440 MARYVILLE, MISSOURI 64468-0440

FASTENERS

METAL ROOF NAIL, SCREWS AND SEALING WASHER

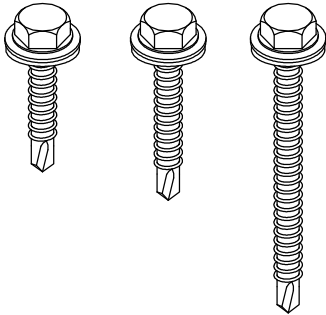

Self-tapping tek screws, hex washer head with neobond weather seal – for use on metal roofing and siding – stainless steel, zinc plated.

Cat. No. 83ST-1 – Size #10, 1" long

Cat. No. 83ST-2 – Size #10, 1-1/2" long

Cat. No. 83ST-3 – Size #10, 2-1/2" long



Stainless steel ringshank nail with metal washer and attached neobond weather seal for use with metal roofing and siding on wood structure.

Cat. No. 83 – Size #10, 2" long

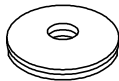

Sealing washer assembly consisting of cone type stainless steel washer with attached neobond sealing washer – for nails to 1/8" diameter.

Cat. No. 210



Self-tapping screw with hex washer head, Size #8.

Cat. No. 83NP-4 – Stainless Steel, 1" long

Cat. No. 83NP-3 – Stainless Steel, 3/4" long, Type A

Cat. No. 83NP-2 – Zinc Plated, 1/2" long

ROBBINS LIGHTNING, INC.

124 EAST SECOND STREET PHONE (660) 582-3156 FAX (660) 582-3039 P.O. BOX 440 MARYVILLE, MISSOURI 64468-0440

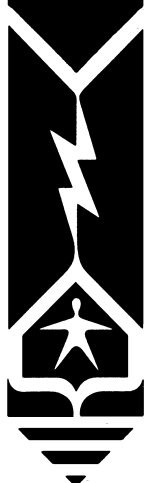

ADEHSIVE COMPOUND

NOTE: Before using any type of adhesive compound, it is important to consult roof manufacturer to determine compatibility with roofing material. Improper use may affect roof warranty.

Cat. No. 690 - 1 Gallon Can

High quality mastic adhesive manufactured by 3M Company for exterior use in attaching Lightning Protection parts to smooth or uneven surfaces - will set up firm within 24 hours of application - compatible with many roof surfaces. On tarred and graveled roof, loose gravel must be cleared, adhesive applied and part set in adhesive. For existing graveled roofs, one gallon will be adequate for 25 point bases or for 50 or more cable holders. On ungraveled felt roof or smooth surface, one gallon will provide adhesive for double the above parts.

Cat. No. 690C - 1 Gallon (2-part mixture)

High quality pourable sealer manufactured by Carlisle especially for use on Carlisle membrane roofing, but may be compatible with other membrane roofs and can also be used on metal surfaces. One gallon is normally adequate for approx. 50 bases or 100 cable holders.

Cat. No. 690F - 1 Gallon (2-part mixture)

High quality pourable sealer manufactured by Firestone especially for use on Firestone membrane roofing, but may be compatible with other membrane roofs and can also be used on metal surfaces. One gallon is normally adequate for approx. 50 bases or 100 cable holders.

Cat. No. 690G - 10 Oz. Tube

Fast drying one-part Silicone Sealant for use on a variety of surfaces, including sheet metal, painted surfaces, masonry, and many other surfaces.

Cat. No. 690LN - 29 Oz. Tube

A specially formulated weatherproof grade adhesive for exterior use on most common building materials.

Cat. No. 690M-1 - 10.1 Oz. Tube

Structural adhesive/sealant manufactured by ChemLink. M-1 is a moisture cure product designed for use in difficult bonding and sealing applications. 1 Tube - Cont. Net 300 ml (10.1 Fl. Oz.) One tube is normally adequate for approx. 10 bases or 25 cable holders.

Cat. No. 690NP-1 - 10.1 Oz. Tube

Gun-grade Polyurethane Sealant manufactured by Sonneborn. NP-1 is designed to bond & seal on flat and gently sloping areas. 1 Tube - Cont. Net 300 ml (10.1 Fl. Oz.) One tube is normally adequate for approx. 10 bases or 25 cable holders.



ROBBINS LIGHTNING, INC.

124 EAST SECOND STREET PHONE (660) 582-3156 FAX (660) 582-3039 P.O. BOX 440 MARYVILLE, MISSOURI 64468-0440